

深圳市正晶浩电子有限公司

SHENZHEN ZJH DISPLAYER TECHNOLOGYCO., LTD

网址: www.zjhlcd.com 电话: 133-9284-8764

MODEL NO(产品型号): HT240S030

2.4 inch LCD TFT

(2.4 英寸真彩色液晶显示屏)

240RGBx320 Resolution and 65K color

(240x320 分辨率, 6 万 5 千种色)

电话: 0755-29355801

传真: 0755-29355801

MOBILE: 13392848764

邮箱: 1553309801@qq.com

QQ: 1553309801

网址: www.zjhlcd.com

深圳市正晶浩电子有限公司

SHENZHEN ZJH DISPLAYER TECHNOLOGYCO., LTD

网址: www.zjhlcd.com 电话: 133-9284-8764

MODEL NO(产品型号): HT240S030

TABLE OF Contents 目录

1. General Descripti 基本描述.....	3
2. Mechanical Specification 机械规格.....	3
3. Mechanical Dimension 机械尺寸图.....	4
4. Electrical Maximum Ratings 电气极限.....	5
5. Brightness characteristic&Power dissipation 亮度特性&功耗.....	5
6. Module Function Description 显示屏脚位定义.....	6
7. Response time&Contrast ratio 响应时间和对比度.....	10
8. Viewing Angle 视角宽度.....	11
9. Reliability Trial 可靠性实验.....	12
10. Inspection Standards 检验标准.....	12
11. Package Method 包装方法.....	14

深圳市正晶浩电子有限公司

SHENZHEN ZJH DISPLAYER TECHNOLOGYCO., LTD

网址: www.zjhlcd.com 电话: 133-9284-8764

MODEL NO(产品型号): HT240S030

1. General Description 基本描述

MODEL NO 产品型号	HT240S030
Display Mode 显示模式	Transmissive 全透
Display Format 显示格式	Graphic 240RGB*320 Dot-matrix 240xRGBx320 图形点阵
Input Data 显示屏接口类型	4 Line-SPI interface 4 线-SPI 串口
Viewing Direction 视角方向	12 o'clock 12 点钟
Drive 显示屏驱动芯片	ST7789V (台湾矽创)

2. Mechanical Specification 机械规格

Item	Specifications	Unit
Dimensional outline 显示屏外围尺寸	42.72(W)*60.16(H)*2.55(T) (不带触摸) 42.72(W)*60.16(H)*3.70(T) (带触摸) (FPC not include)	mm
Resolution 分辨率	240RGB*320	dots
LCD Active area 显示尺寸	36.72(W)*48.96 (H)	mm
Pixel size 像素尺寸	0.153(W)*0.153(H)	mm

深圳市正晶浩电子有限公司

SHENZHEN ZJH DISPLAYER TECHNOLOGYCO., LTD

网址: www.zjhlcd.com 电话: 133-9284-8764

MODEL NO(产品型号): HT240S030

3.Mechanical Dimension 机械尺寸图

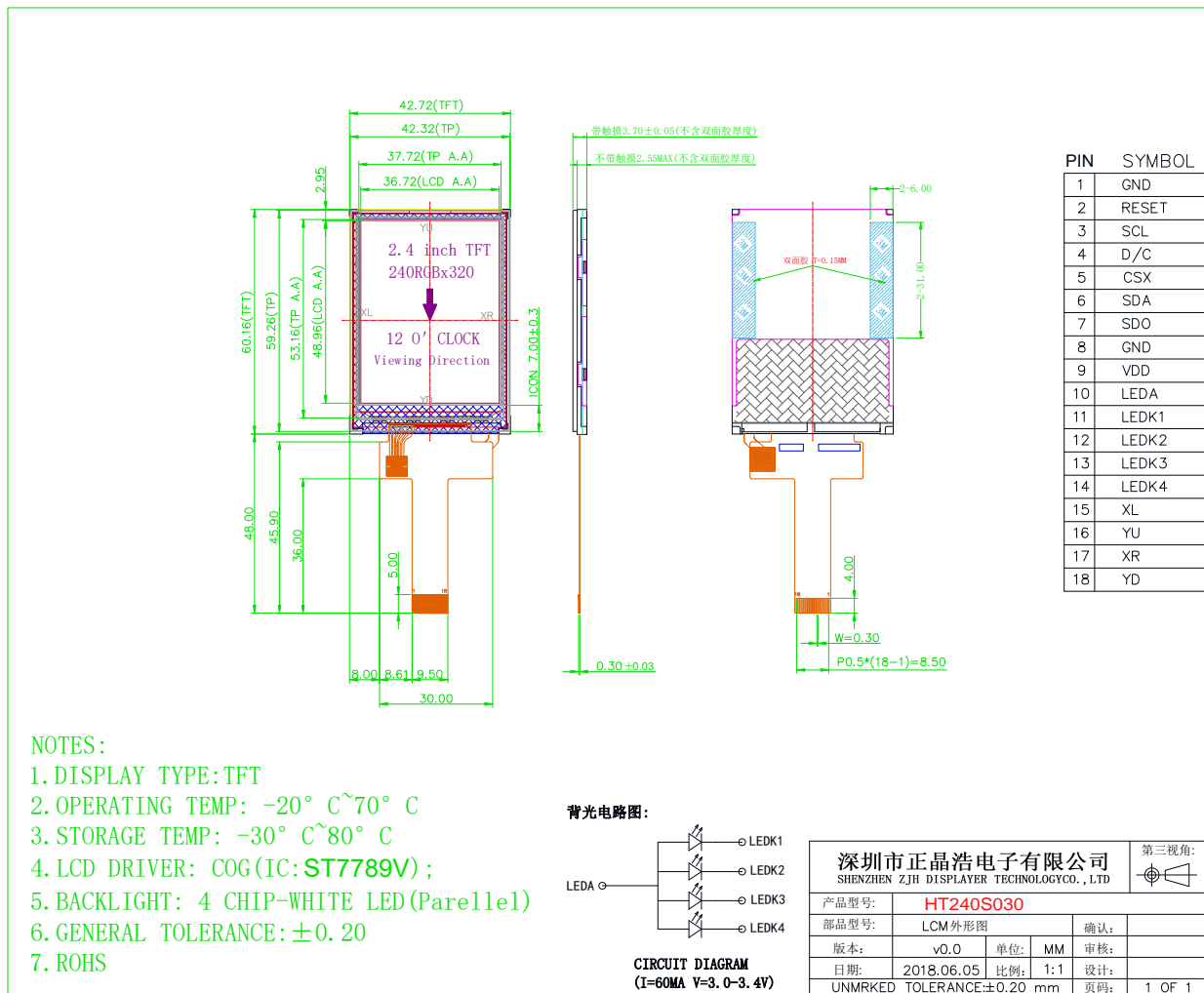

深圳市正晶浩电子有限公司

SHENZHEN ZJH DISPLAYER TECHNOLOGYCO., LTD

网址: www.zjhlcd.com 电话: 133-9284-8764

MODEL NO(产品型号): HT240S030

4. Electrical Maximum Ratings 电气极限

Item 项目	Symbol 符号	Min 最小值	Max 最大值	Unit 单位	Note 备注
Supply voltage (VDDI) 工作电压(VDDI)	V	1.8	3.3	V	-
Supply voltage (VDD) 工作电压(VDD)	V	2.8	3.3	V	-
Operating temperature 工 作温度范围	T _{OPR}	-20	70	℃	-
Storage temperature 存储温度范围	T _{STR}	-30	80	℃	-

※NOTE: VDDI 和 VDD 可以直接连一起, 共用一组 (2.8V~3.3V) 电压供电。

5. Brightness characteristic&Power dissipation 亮度特性&功耗

Item 项目	Symbol 符号	Min 最小值	Typical 典型值	Max 最大值	Unit
LED module Forward voltage LED 背光源正向电压	V _{LED}	2.9	3.1	3.3	V
LED module current LED 背光源电流	I _{LED}	-	60	-	mA
LCD Surface Luminance 显示屏表面亮度	L _S	250	300	-	Cd/m ²
LCM Surface brightness uniform LED 背光源均匀度	L _D	80	-	-	%
LCD power dissipation 显示屏总功耗	P _{LCD}	-	0.22	-	W

※NOTE: $P_{LCD} = VDD * (I_{LED} + I_{LCD})$

深圳市正晶浩电子有限公司

SHENZHEN ZJH DISPLAYER TECHNOLOGYCO., LTD

网址: www.zjhlcd.com 电话: 133-9284-8764

MODEL NO(产品型号): HT240S030

6. Module Function Description 显示屏脚位定义

PIN No. 引脚序号	Symbol 引脚名称	Description 作用描述	Notes 备注
1	GND	Ground (接地脚)	-
2	RESET	-This signal will reset the device and it must be applied to properly initialize the chip. -Signal is active low. (显示屏复位脚, 低电平有效)	-
3	SCL	-This pin is used to be serial interface clock. (4线-SPI 串口时钟)	-
4	D/C	- Display data/command selection pin in 4-line serial interface. (4线-SPI 数据/指令选择选择脚)	-
5	CSX	-Chip selection pin Low enable. High disable. (显示屏驱动芯片选脚, 低电平使能)	-
6	SDA	SPI interface input pin. -The data is latched on the rising edge of the SCL signal. -If not used, please fix this pin at VDDI or DGND level. (4线-SPI 数据输入, 不用时接 VDDI 或 GND)	-
7	SDO	-SPI interface output pin. -The data is output on the falling edge of the SCL signal. -If not used, let this pin open. (4线-SPI 数据输出, 不用时悬空)	-

深圳市正晶浩电子有限公司

SHENZHEN ZJH DISPLAYER TECHNOLOGYCO., LTD

网址: www.zjhlcd.com 电话: 133-9284-8764

MODEL NO(产品型号): HT240S030

8	GND	Ground (接地脚)	-
9	VDD	Power Supply for Analog, Digital System and Booster Circuit. (显示屏主电源供电脚 2.8-3.3V)	-
10	LEDA	Anode of Backlight (2.9V-3.3V Typical:3.1V) (背光正极供电脚, 电压范围:2.9-3.3V, 典型值:3.1V)	-
11	LEDK1	Cathode of Backlight (背光负极供电脚)	-
12	LEDK2	Cathode of Backlight (背光负极供电脚)	-
13	LEDK3	Cathode of Backlight (背光负极供电脚)	-
14	LEDK4	Cathode of Backlight (背光负极供电脚)	-
15	XL	Touch panel Logical foot (四线电阻触摸屏逻辑脚)	-
16	YU	Touch panel Logical foot (四线电阻触摸屏逻辑脚)	-
17	XR	Touch panel Logical foot (四线电阻触摸屏逻辑脚)	-
18	YD	Touch panel Logical foot (四线电阻触摸屏逻辑脚)	-

深圳市正晶浩电子有限公司

SHENZHEN ZJH DISPLAYER TECHNOLOGYCO., LTD

网址: www.zjhlcd.com 电话: 133-9284-8764

MODEL NO(产品型号): HT240S030

附图 6-1: 显示屏 YT240S030_4 线-SPI 串口参考应用电路

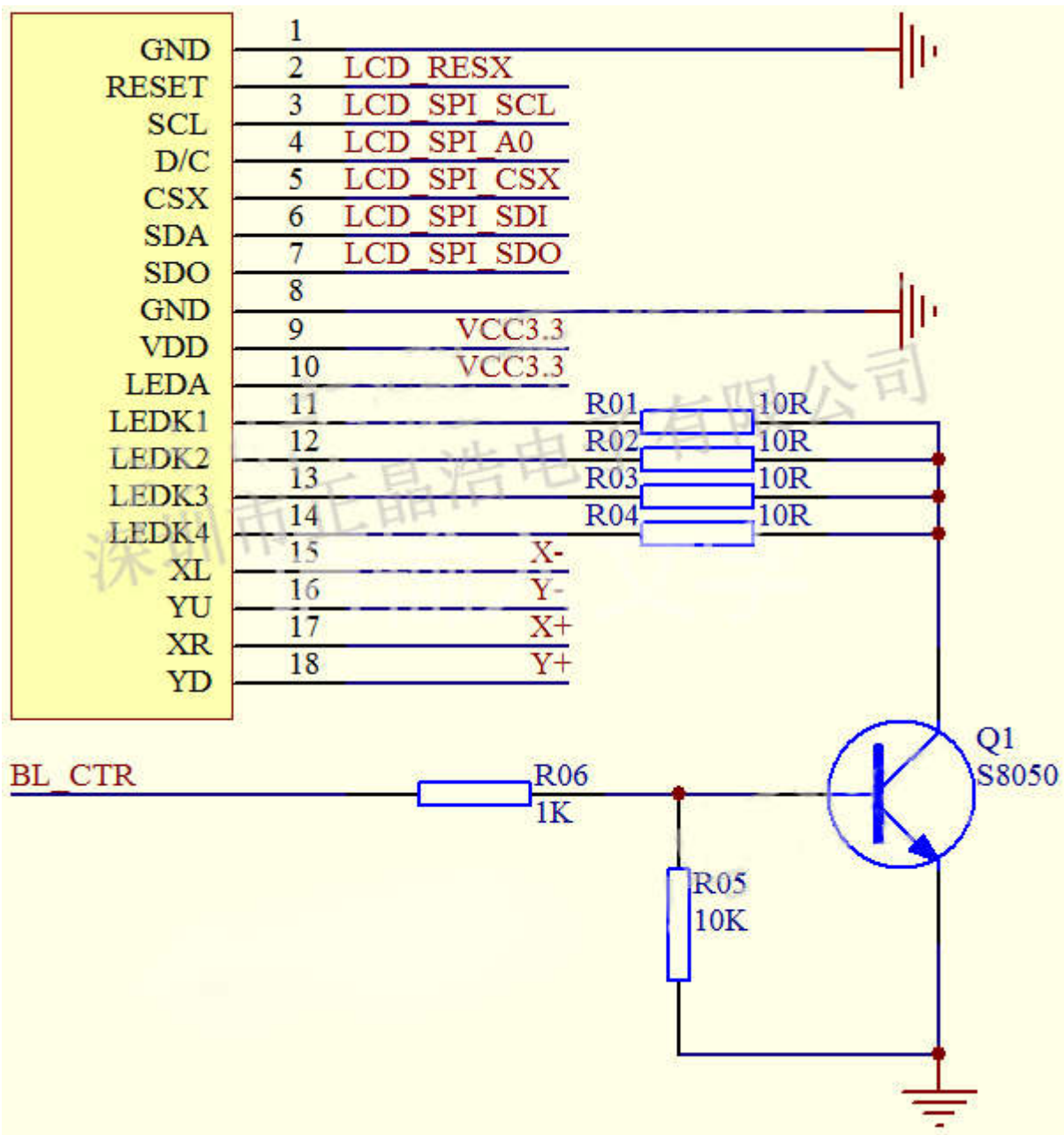

深圳市正晶浩电子有限公司

SHENZHEN ZJH DISPLAYER TECHNOLOGYCO., LTD

网址: www.zjhlcd.com 电话: 133-9284-8764

MODEL NO(产品型号): HT240S030

附图 6-2: 触摸屏参考应用电路

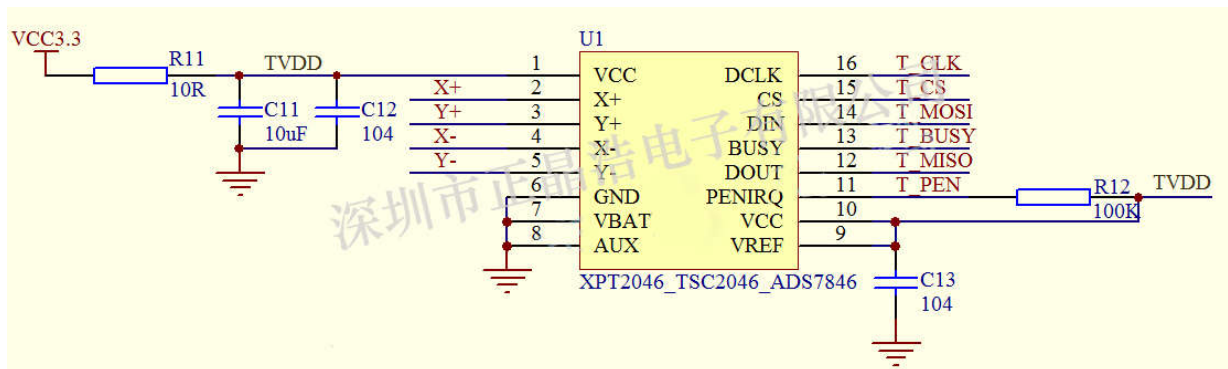

※NOTE:

- 1.若为不带触摸版本, 参考附图 6-1 连接电路, 把显示屏的 XL、YU、XR、YD 四个触摸脚悬空即可。
- 2.若为带触摸版本, 参考附图 6-2 触摸应用连接电路。

深圳市正晶浩电子有限公司

SHENZHEN ZJH DISPLAYER TECHNOLOGYCO., LTD

网址: www.zjhlcd.com 电话: 133-9284-8764

MODEL NO(产品型号): HT240S030

7.Response time&Contrast ratio 响应时间与对比度

Item 项目	Symbol 符号	Condition 条件	Remark			Unit 单位
			Min. 最小值	Typ. 典型值	Max. 最大值	
Response time 响应时间	Tr+Tf	$\theta = 0^\circ$	-	25	40	ms
Contrast ratio 对比度	CR	$\theta = 0^\circ$	350	500	-	-

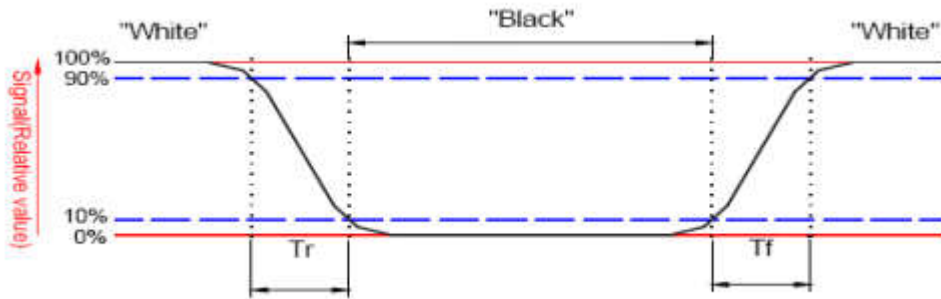

响应时间图示

$$\text{Contrast ratio (CR)} = \frac{\text{Brightness on the "white" state}}{\text{Brightness on the "black" state}}$$

对比度计算公式

深圳市正晶浩电子有限公司

SHENZHEN ZJH DISPLAYER TECHNOLOGYCO., LTD

网址: www.zjhlcd.com 电话: 133-9284-8764

MODEL NO(产品型号): HT240S030

8.Viewing Angle 视角宽度

Item 项目	Symbol 符号	Condition 条件	Remark			Unit 单位
			Min. 最小值	Typ. 典型值	Max. 最大值	
Viewing angle 视角宽度	Top 12点钟方向	$CR \geq 10$ 对比度大于等于 10	40	50	-	Deg. 度
	Bottom 6点钟方向	$CR \geq 10$ 对比度大于等于 10	55	65	-	
	Left 9点钟方向	$CR \geq 10$ 对比度大于等于 10	55	65	-	
	Right 3点钟方向	$CR \geq 10$ 对比度大于等于 10	55	65	-	

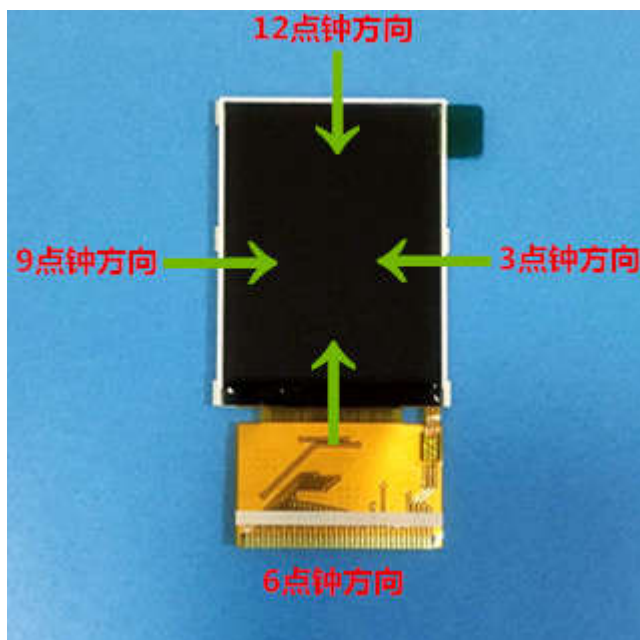

垂直于屏表面

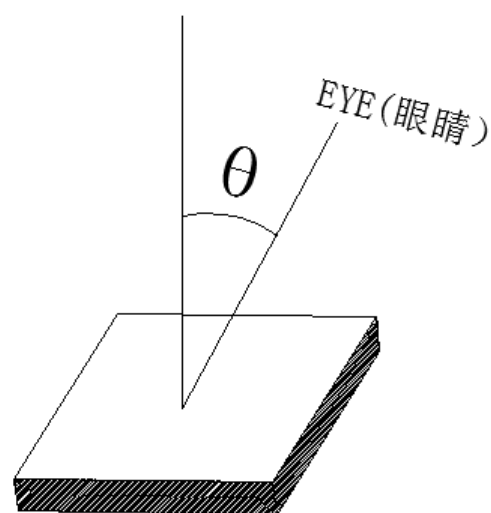

NOTE:3点,6点,9点,12点方向视角的大小指的是垂直于屏表面的线眼睛视线之间的夹角(θ)。

深圳市正晶浩电子有限公司

SHENZHEN ZJH DISPLAYER TECHNOLOGYCO., LTD

网址: www.zjhlcd.com 电话: 133-9284-8764

MODEL NO(产品型号): HT240S030

9. Reliability Trial 可靠性实验

NO. 序号	ITEM 实验项目	CONDITION 实验环境	CRITERION 实验规范
1	High Temperature Non-Operating Test 高温存储实验	80°C*120Hrs	No Defect Of Operational Function In Room Temperature Are Allowable 室温运行功能无缺陷
2	Low Temperature Non-Operating Test 低温存储实验	-30°C*120Hrs	
3	High Temperature/Humidity Non Operating Test 高温高湿实验	60°C*90%RH*120Hrs	
4	High Temperature Operating Test 高温工作实验	70°C*72Hrs	
5	Low Temperature Operating Test 低温工作实验	-20°C*72Hrs	
6	Thermal Shock Test 热冲实验	-20 °C (30Min) ↔70 °C (30Min) *10CYCLES	

10. Inspection standards 检验标准

10.1 Glass defect

NO	Defect item	Criteria	Remark
1	Dimension Unconformity (Major defect)	By Engineering Drawing	
2	Cracks (Major defect)	1. Linear cracks panel 【Reject】 2. Nonlinear crack contrast by limited sample	
3	Glass extrude the conductive area (minor defect)	a: disregards and no influence assemblage. 1) $b \leq 1/3$ Pin width(non bonding area) 【Accept】 2) bonding area ≤ 0.5 mm 【Accept】	A: Length, b: Width
4	Pin-side ,conductive area damaged (minor defect)	(a c: disregards) $b \leq 1/3$ of effective length for bonding electrode 【Accept】	a: length, b: Width, c: Thickness

深圳市正晶浩电子有限公司

SHENZHEN ZJH DISPLAYER TECHNOLOGYCO., LTD

网址: www.zjhlcd.com 电话: 133-9284-8764

MODEL NO(产品型号): HT240S030

5	Pin-side, non-conductive area damaged (minor defect)	<p>1) Damage area don't touch the ITO (Including contraposition mark, except scribing mark) 【Accept】</p> <p>2) $C < T$ $b \leq BM1/3$ of width 【Accept】</p> <p>3) $c = T$ b not touch the seal glue 【Accept】</p> <p>4) a disregards</p>	<p>a: Length, b: Width c: Thickness</p>
6	Non-pin-side damage (minor defect)	<p>$c < T$</p> <p>1) b exceeds $1/3 B_m$ 【Reject】</p> <p>$c = T$ b not touch the seal glue 【Reject】</p>	<p>c: Thickness b: width of</p>

10.2 LCD appearance defect (View area)

NO	Defect item	Criteria		Remark
		Specification	Allowable	
1	Fiber, glass cratch, polarizer scratch/folded (minor defect)	$W \leq 0.03\text{mm}$	disregard	<p>note1: L: Length, W: Width</p> <p>note2: disregard if out of AA</p>
		$0.03\text{mm} < W \leq 0.05\text{mm};$ $L \leq 3.0\text{mm}$	2	
		$0.05\text{mm} < W \leq 0.1\text{mm};$ $L \leq 3.0\text{mm}$	1	
		$W > 0.1\text{mm}; L > 3.0\text{mm}$	0	
2	Polarizer bubble, concave and convex (minor defect)	$\phi \leq 0.2\text{mm}$	disregard	<p>note1: $\phi = (L+W)/2$, L: Length, W: Width</p> <p>note2: disregard if out of AA</p>
		$0.2\text{mm} < \phi \leq 0.3\text{mm}$	2	
		$0.3\text{mm} < \phi \leq 0.5\text{mm}$	1	
		$0.5\text{mm} < \phi$	0	
3	Black dots, dirty dots, impurities, eye winker	$\phi \leq 0.15\text{mm}$	disregard	note2: disregard if out of AA
		$0.15\text{mm} < \phi \leq 0.25\text{mm}$	2	

深圳市正晶浩电子有限公司

SHENZHEN ZJH DISPLAYER TECHNOLOGYCO., LTD

网址: www.zjhlcd.com 电话: 133-9284-8764

MODEL NO(产品型号): HT240S030

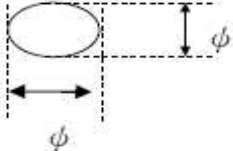
	(minor defect)	$0.25\text{mm} < \phi \leq 0.3\text{mm}$	1	
		$0.3\text{mm} < \phi$	0	
4	Polarizer prick (minor defect)	$\phi \leq 0.1\text{mm}$	disregard	note1: $\phi = (L+W)/2$, L=Length, W=Width
		$0.1\text{mm} < \phi \leq 0.25\text{mm}$	3	
		$\phi > 0.25\text{mm}$	0	note2: the distance between two dots > 5mm

11.Package Method 包装方法

显示屏出货包装示意图:

深圳市正晶浩电子有限公司

SHENZHEN ZJH DISPLAYER TECHNOLOGYCO., LTD

网址: www.zjhlcd.com 电话: 133-9284-8764

MODEL NO(产品型号): HT240S030

