

# 深圳市正晶浩电子有限公司

SHENZHEN ZJH DISPLAYER TECHNOLOGYCO., LTD

服务热线: 133 9284 8764

## APPROVAL SHEET

### 承认书

记录编号: 版本: v0.0

Customer 客户名称	
Part NO. 产品型号	Z280IT010
Product type 产品内容	Mode: Transmissive type .Normally white. TFT LCD Module LCD Module: Graphic 240RGB*320Dot-matrix
Remarks 备注栏	<input type="checkbox"/> APPROVAL FOR SEPCIFICATIONS ONLY <input checked="" type="checkbox"/> APPROVAL FOR SEPCIFICATIONS AND SAMPLE
Signature by Customer: 客户确认签章	

核准	审核	定制

#### 客户确认

核准	审核	审核

# 深圳市正晶浩电子有限公司

SHENZHEN ZJH DISPLAYER TECHNOLOGYCO., LTD

服务热线: 133 9284 8764

---

## TABLE OF Contents

1. General Description.....	3
2. Features.....	3
3. Mechanical Specification.....	3
4. Mechanical Dimension.....	4
5. Maximum Ratings.....	5
6. Electrical Characteristics.....	5
7. Backlight Characteristic.....	5
8. Module Function Description.....	7
9. Electro-optical Characteristics.....	10
10. Reliability.....	14
11. Inspection Standards.....	15
12. Precautions For Using LCD Modules.....	19
13. Revision History.....	20

# 深圳市正晶浩电子有限公司

## SHENZHEN ZJH DISPLAYER TECHNOLOGYCO., LTD

服务热线: 133 9284 8764

### 1. General Description

Z280IT010 is a 240RGB\*320 dots matrix TFT LCD module. It has a TFT panel composed of 720 sources and 320gates. The LCM can be easily accessed by micro-controller.

### 2. Features

Display Mode	Transmissive
	a-TFT
Display Format	Graphic 320RGB*480 Dot-matrix
Input Data	4 线串口(SPI-4WIRE)
Viewing Direction	12 o'clock
Drive	ILI9341

### 3. Mechanical Specification

Item	Specifications	Unit
Dimensional outline	50.00(W)*69.20(H)*3.60MAX (T) (FPC not include)	mm
Resolution	240RGB*320	dots
LCD Active area	43.20(W)*57.60(H)	mm
Pixel size	0.180(W)*0.180(H)	mm

### 4. Mechanical Dimension

# 深圳市正晶浩电子有限公司

## SHENZHEN ZJH DISPLAYER TECHNOLOGYCO., LTD

服务热线: 133 9284 8764

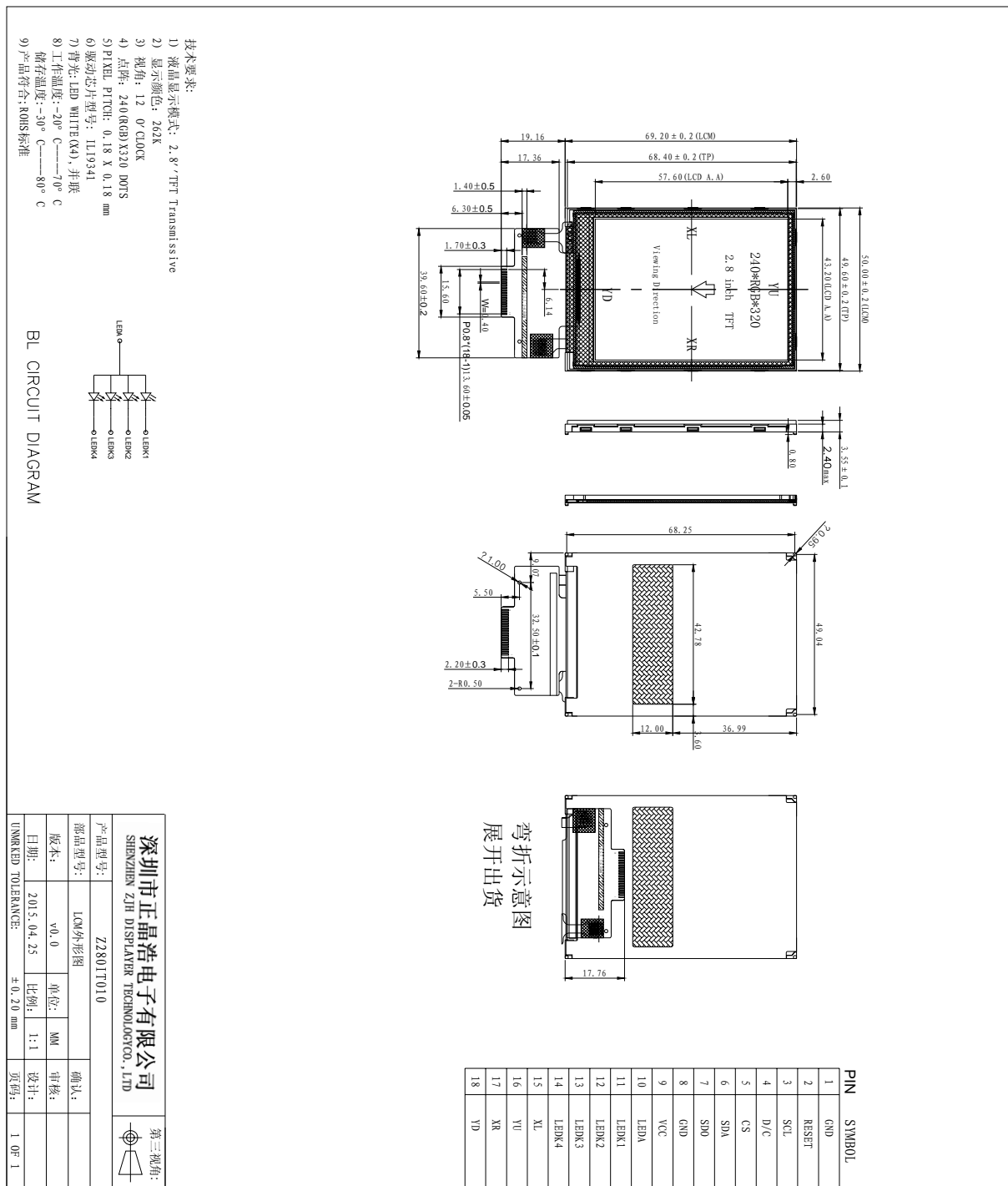

产品型号: Z2801T010		确认:	
LCM外形图		审核:	
版本号: v0.0	单位: MM	设计:	
日期: 2015.04.25	比例: 1:1	页码:	1 OF 1
UNMARKED TOLERANCE: ±0.20 mm			

深圳市正晶浩电子有限公司  
SHENZHEN ZJH DISPLAYER TECHNOLOGYCO., LTD



# 深圳市正晶浩电子有限公司

SHENZHEN ZJH DISPLAYER TECHNOLOGYCO., LTD

服务热线: 133 9284 8764

## 5. Maximum Ratings

Item	Symbol	Min	Max	Unit	Note
Supply voltage	V	-0.3	4.6	V	
Operating temperature	V <sub>T</sub>	-0.3	V <sub>CC</sub> +0.3	V	
Storage temperature	T <sub>OPR</sub>	-20	70	°C	
Storage temperature	T <sub>STR</sub>	-30	80	°C	

## 6. Electrical Characteristics

Item	Symbol	Condition	Min.	Typ.	Max.	Unit
Supply voltage	V <sub>CC</sub>		2.7	2.8	3.3	V
Input Voltage	H level	T <sub>IH</sub>	0.8*IOVCC		IOVCC	V
	L level	T <sub>IL</sub>	-0.3		0.2* IOVCC	
Storage temperature	I <sub>DD</sub>	With internal voltage generation V <sub>CC</sub> =2.8V; T <sub>emp</sub> =25°C			TBD	mA

## 7. Backlight Characteristic

Item	Symbol	Min	Typical	Max	Unit
LED module Forward voltage	V <sub>LED</sub>	3.0	3.2	3.4	V
LED module current	V <sub>LED</sub>		90		mA
L/G Surface Luminance ★1	L <sub>S</sub>	3200			Cd/m <sup>3</sup>
LCM Surface brightness uniform ★2	L <sub>D</sub>	80			%

★ 1Test condition is:

(a) Center point on active area.

(b)Best Contrast.

★2Uniform measure condition:

(1)Measure 9 point. Measure location show below;

(2)Uniform=(Min. brightness /Max. brightness)\*100%

# 深圳市正晶浩电子有限公司

SHENZHEN ZJH DISPLAYER TECHNOLOGYCO., LTD

服务热线: 133 9284 8764

(3)Best Contrast.

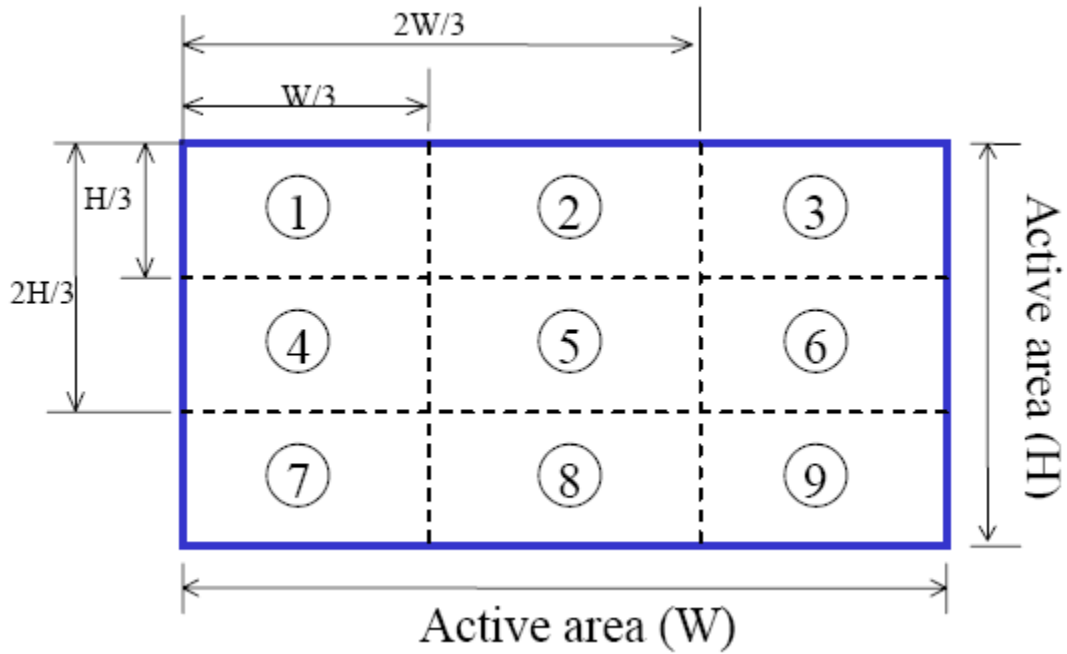

# 深圳市正晶浩电子有限公司

SHENZHEN ZJH DISPLAYER TECHNOLOGYCO., LTD

服务热线: 133 9284 8764

## 8. Module Function Description

### 8.1 Pin Descriptions

PIN No.	Symbol	Description
1	GND	Ground (接地脚)
2	RESET	LCM Reset pin Signal is active low. (屏复位脚, 低电平复位)
3	SCL	This pin is used serial interface clock in 4-wire 8-bit serial data interface. (4线串口的时钟信号) <b>If not used, this pin should be connected to IOVCC or GND.</b> (不用时接IOVCC或者接地)
4	D/C	- 4-line system (D/CX): Serves as command or parameter select. <b>Fix to IOVCC level when not in use.</b> (4线串口的寄存器/数据选择, 不用时接 IOVCC)
5	CS	Chip select pin ("Low" enable) (屏驱动芯片片选脚, 低电平有效)
6	SDA	Serial input signal. The data is applied on the rising edge of the SCL signal. <b>If not used, fix this pin at IOVCC or GND</b> (串口数据输入信号, 不用时接 IOVCC 或者接地)
7	SDO	Serial output signal. The data is outputted on the falling edge of the SCL signal. <b>If not used, open this pin</b> (串口数据输出信号, 不用时悬空)
8	GND	Ground (接地脚)
9	VCC	Power supply for LCM (2.8V-3.3V) (屏供电脚)
10	LEDA	Anode of Backlight (3.0V-3.4V Typical:3.2V) (背光正极供电脚, 电压范围:3.0-3.4V, 典型值:3.2V)
11	LEDK1	Cathode of Backlight (背光负极供电脚)
12	LEDK2	Cathode of Backlight

# 深圳市正晶浩电子有限公司

SHENZHEN ZJH DISPLAYER TECHNOLOGYCO., LTD

服务热线: 133 9284 8764

		(背光负极供电脚)
13	LEDK3	Cathode of Backlight (背光负极供电脚)
14	LEDK4	Cathode of Backlight (背光负极供电脚)
15	XL	Touch panel control pin (触摸屏控制脚)
16	YU	Touch panel control pin (触摸屏控制脚)
17	XR	Touch panel control pin (触摸屏控制脚)
18	YD	Touch panel control pin (触摸屏控制脚)

关于供电说明:

**IOVCC 和 VCC 连一起, 用 2.8V-3.3V 供电; 背光 LED 可以单独供电 (3.0-3.4 V), 也可以和 VCC 共用一组电压 (A 为正接 VCC, K 连一起作为负接地).**

## 8.2 Timing characteristics.



### 18.3.4 Display Serial Interface Timing Characteristics (4-line SPI system)

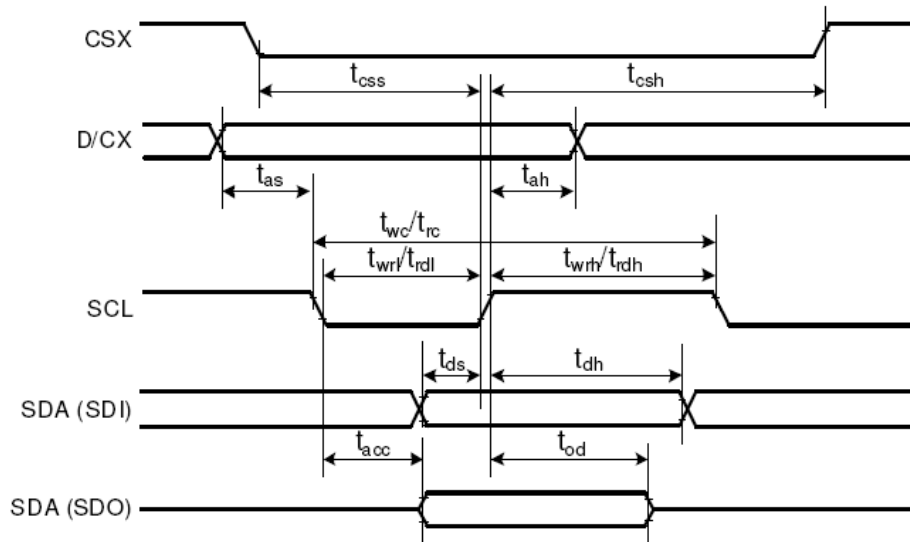

Signal	Symbol	Parameter	min	max	Unit	Description
CSX	$t_{css}$	Chip select time (Write)	40	-	ns	
	$t_{csh}$	Chip select hold time (Read)	40	-	ns	
SCL	$t_{wc}$	Serial clock cycle (Write)	100	-	ns	
	$t_{wrh}$	SCL "H" pulse width (Write)	40	-	ns	
	$t_{wrl}$	SCL "L" pulse width (Write)	40	-	ns	
	$t_{rc}$	Serial clock cycle (Read)	150	-	ns	
	$t_{rdh}$	SCL "H" pulse width (Read)	60	-	ns	
	$t_{rdl}$	SCL "L" pulse width (Read)	60	-	ns	
D/CX	$t_{as}$	D/CX setup time	10	-		
	$t_{ah}$	D/CX hold time (Write / Read)	10	-		
SDA / SDI (Input)	$t_{ds}$	Data setup time (Write)	30	-	ns	
	$t_{dh}$	Data hold time (Write)	30	-	ns	
SDA / SDO (Output)	$t_{acc}$	Access time (Read)	10	-	ns	For maximum $C_L=30\text{pF}$
	$t_{od}$	Output disable time (Read)	10	50	ns	For minimum $C_L=8\text{pF}$

Note:  $T_a = 25^\circ\text{C}$ ,  $V_{DDI}=1.65\text{V to }3.3\text{V}$ ,  $V_{CI}=2.5\text{V to }3.3\text{V}$ ,  $AGND=VSS=0\text{V}$

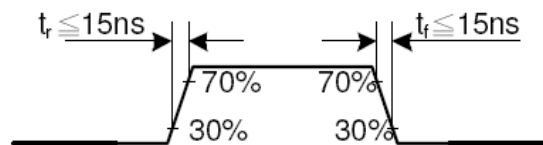

# 深圳市正晶浩电子有限公司

SHENZHEN ZJH DISPLAYER TECHNOLOGYCO., LTD

服务热线: 133 9284 8764

## 9. Electro-optical Characteristics

Item	Symbol	Conditions	Temp	Min.	Typ.	Max.	Unit	Note
Response Time	$T_R$	$\theta = \phi = 0$	25°C		TBD	TBD	msec	NOTE2
	$T_F$				TBD	TBD		
Viewing Angle Range	$\phi = 0^{\circ} (6'' )$	$\phi = 90^{\circ} (3'' )$		$\phi = 180^{\circ} (12'' )$		$\phi = 270^{\circ} (9'' )$		NOTE3
$\theta (25^{\circ}C) CR \geq 10$	TBD	TBD		TBD		TBD		NOTE3

The above “viewing angle” is the measuring position with the largest contrast ratio. Not for good image quality. Viewing direction for good image quality is 12 O’clock.

- For panel only
- Electro-Optical Characteristics Test Method

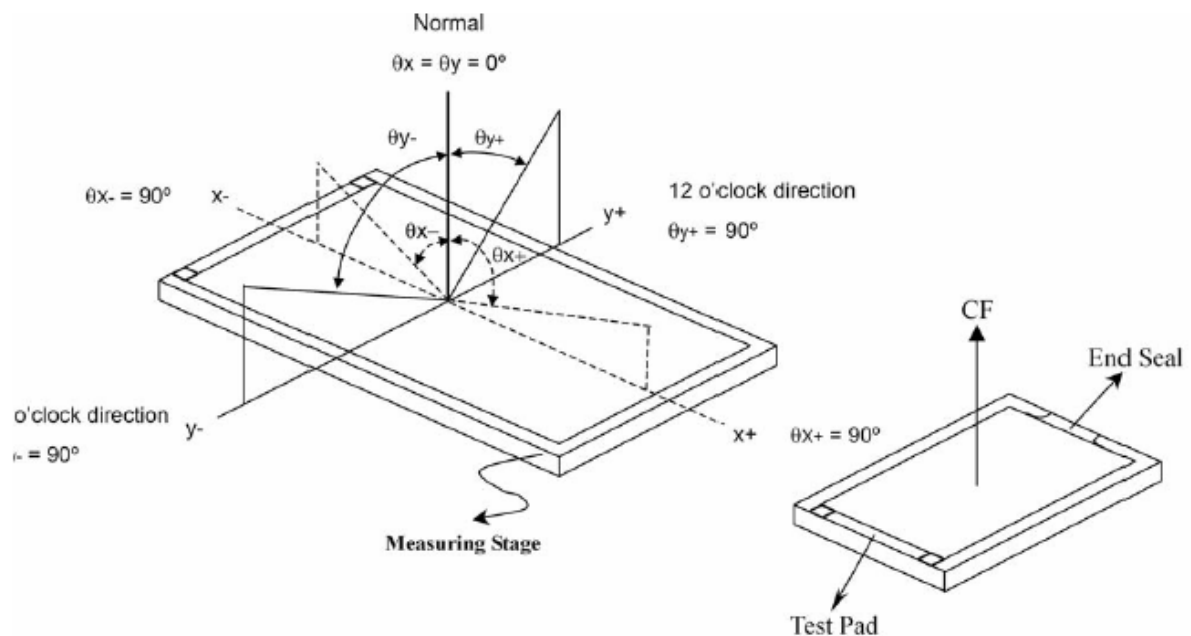

$$V_{op} = (V_{10, ON} + V_{90, OFF})/2$$

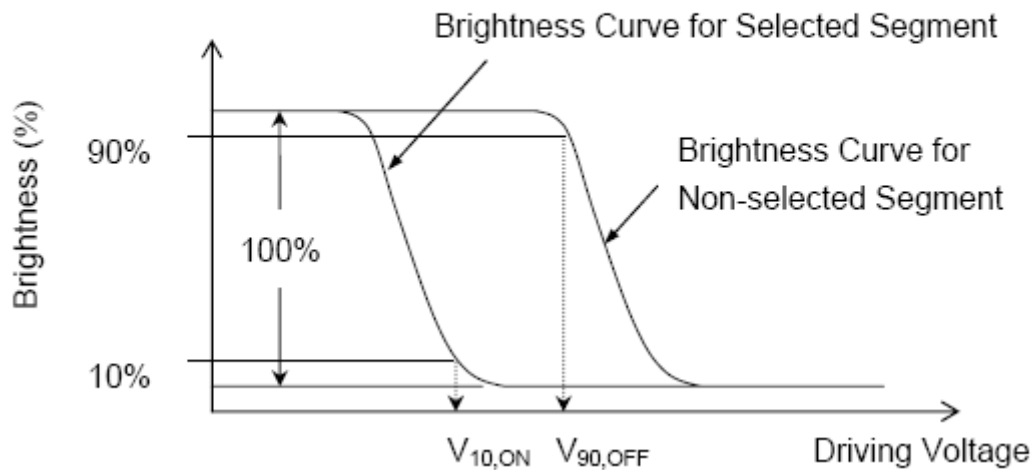

**.Note2.Definition of Optical Response Time:**

# 深圳市正晶浩电子有限公司

SHENZHEN ZJH DISPLAYER TECHNOLOGYCO., LTD

服务热线: 133 9284 8764

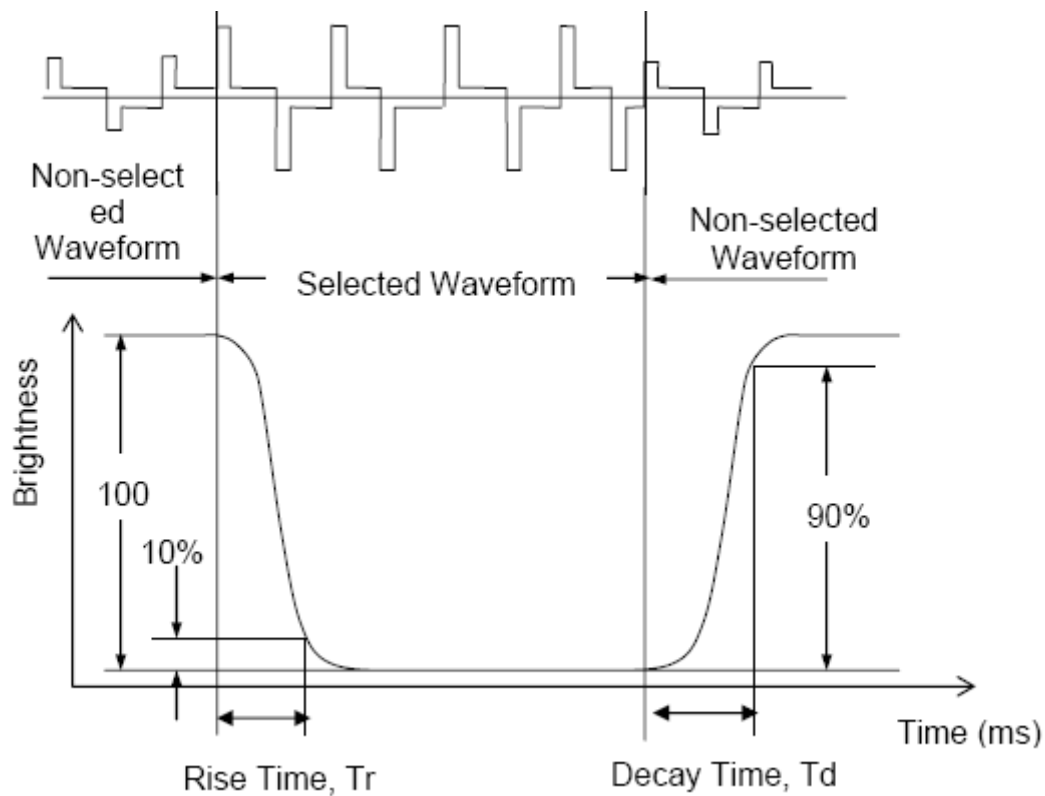

**.Note3.Definition of Viewing Angle  $\theta$  and  $\phi$  :**

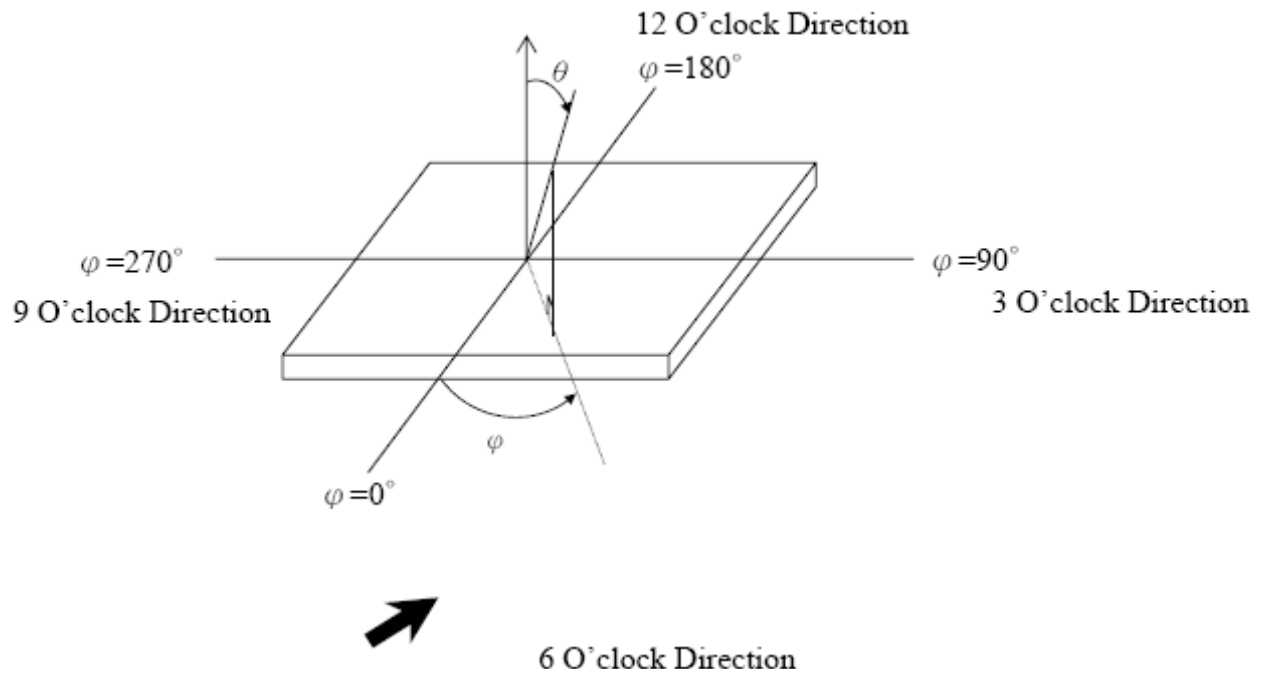

**Note4.Definition of Contrast ratio (CR):**

# 深圳市正晶浩电子有限公司

## SHENZHEN ZJH DISPLAYER TECHNOLOGYCO., LTD

服务热线: 133 9284 8764

$$CR = \frac{\text{Brightness of Non-selected Segment (B2)}}{\text{Brightness of Selected Segment (B1)}}$$

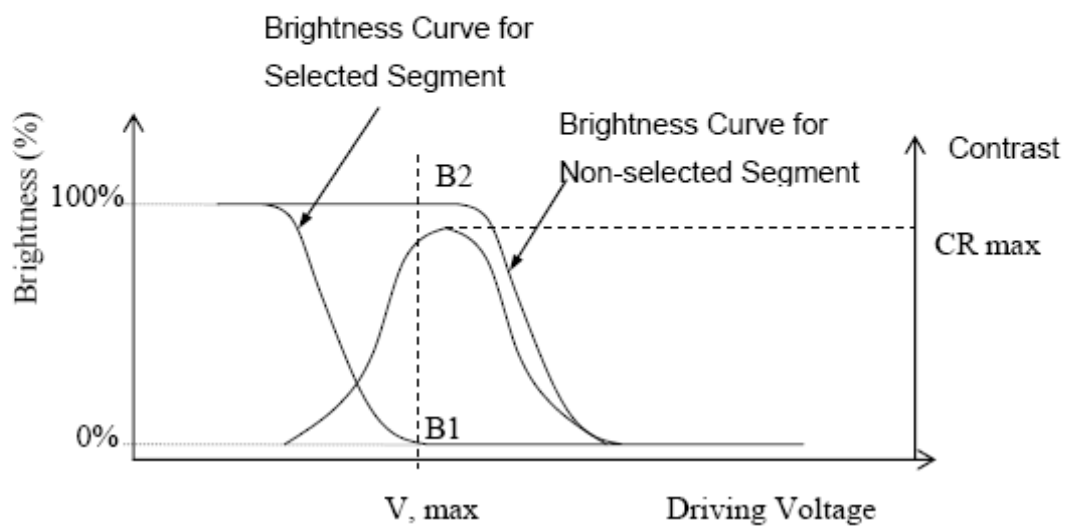

## 10. Reliability

### 10.1Mtbf

The LCD module shall be designed to meet a minimum MTBF value of 50000 hours with normal

### 10.2Test condition

NO.	ITEM	CONDITION	CRITERION
1	High Temperature Non-Operating Test	80°C*240Hrs	。 No Defect Of Operational Function In Room Temperature Are Allowable 。 IDD of LCM in Pre-and Post-Test Should Follow Specification
2	Low Temperature Non-Operating Test	-30°C*240Hrs	
3	High Temperature/Humidity Non Operating Test	60°C*90%RH*240Hrs	
4	High Temperature Operating Test	70°C*240Hrs	
5	Low Temperature Operating Test	-20°C*240Hrs	
6	Thermal Shock Test	-20°C (30Min) ↔ 70°C (30Min) *10CYCLES	

Notes:

1. Judgments should be made after exposure in room temperature for two hours.
2. The distill water is used for the high temperature/humidity test.
3. The sample above is individually for every reliability tests condition.

# 深圳市正晶浩电子有限公司

## SHENZHEN ZJH DISPLAYER TECHNOLOGYCO., LTD

服务热线: 133 9284 8764

### 11. Inspection standards

1. AQL (Acceptable Quality Level)

AQL of major and minor defect.

	MAJOR DEFECT	MINOR DEFECT
AQL	0.65	1.5

### 2. Basic conditions for inspection

The LCM face to us, in normal environment, the lux is  $1000 \pm 200$ . (Darkroom's lux:  $100 \pm 50$ ), About an angle of incidence  $30^\circ$ , a distance of 30 cm with an angle of  $45 \pm 10^\circ$  to check the products without uncovering the film!

(As shown below)

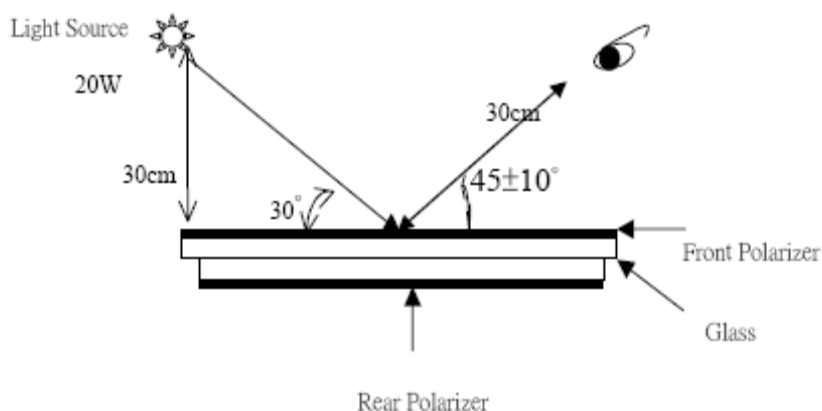

### 3. Inspection item and criteria

#### 3.1 Visual inspection criterion in immobility

##### 3.1.1 Glass defect

NO	Defect item	Criteria	Remark
1	Dimension Unconformity (Major defect)	By Engineering Drawing	
2	Cracks (Major defect)	1. Linear cracks panel 2. Nonlinear crack contrast by limited sample	【Reject】 
3	Glass extrude the conductive area (minor defect)	a: disregards and no influence assemblage. 1) $b \leq 1/3$ Pin width (non bonding)	A: Length, b: Width

# 深圳市正晶浩电子有限公司

## SHENZHEN ZJH DISPLAYER TECHNOLOGYCO., LTD

服务热线: 133 9284 8764

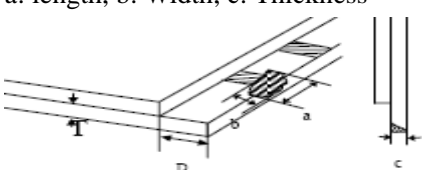
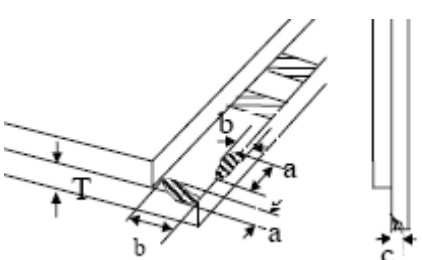
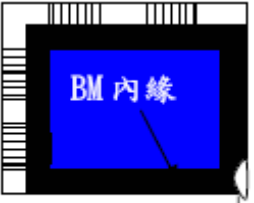
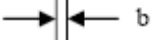
		area) 【Accept】 2)bonding area $\leq$ 0.5mm 【Accept】	
4	Pin-side ,conductive area damaged (minor defect)	(a c: disregards) $b \leq 1/3$ of effective length for bonding electrode 【Accept】	a: length, b: Width, c: Thickness 
5	Pin-side,non-conductive area damaged (minor defect)	1)Damage area don't touch the ITO (Including contraposition mark, except scribing mark) 【Accept】 2) $C < T$ $b \leq BM/3$ of width 【Accept】 3) $c = T$ b not touch the seal glue 【Accept】 4)a disregards	a: Length, b: Width c: Thickness 
6	Non-pin-side damage (minor defect)	$c < T$ 1)b exceeds $1/3BM$ 【Reject】 $c = T$ b not touch the seal glue 【Reject】	c: Thickness b: width of  damage 

### 3.1.2LCD appearance defect(View area)

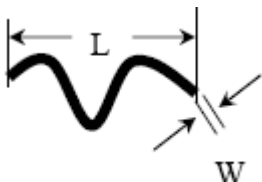
NO	Defect item	Criteria		Remark
		Specification	Allowable	
1	Fiber、 glass cratch、 polarizer scratch/folded (minor defect)	$W \leq 0.03mm$	disregard	note1:L: Length, W: Width note2: disregard if out of AA 
		$0.03mm < W \leq 0.05mm$ ; $L \leq 3.0mm$	2	
		$0.05mm < W \leq 0.1mm$ ; $L \leq 3.0mm$	1	
		$W > 0.1mm$ ; $L > 3.0mm$	0	



# 深圳市正晶浩电子有限公司

## SHENZHEN ZJH DISPLAYER TECHNOLOGYCO., LTD

服务热线: 133 9284 8764

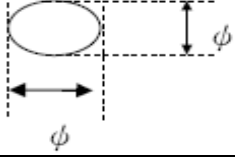
2	Polarizer bubble、 concave and convex (minor defect)	$\phi \leq 0.2\text{mm}$	disregard	note1: $\phi = (L+W)/2$ , L:Length, W :Width note2:disregard if out of AA
		$0.2\text{mm} < \phi \leq 0.3\text{mm}$	2	
		$0.3\text{mm} < \phi \leq 0.5\text{mm}$	1	
		$0.5\text{mm} < \phi$	0	
3	Black dots、dirty dots、 impurities、eye winker (minor defect)	$\phi \leq 0.15\text{mm}$	disregard	note2:disregard if out of AA 
		$0.15\text{mm} < \phi \leq 0.25\text{mm}$	2	
		$0.25\text{mm} < \phi \leq 0.3\text{mm}$	1	
		$0.3\text{mm} < \phi$	0	
4	Polarizer prick (minor defect)	$\phi \leq 0.1\text{mm}$	disregard	note1: $\phi = (L+W)/2$ , L=Length, W=Width note2:the distance between two dots>5mm
		$0.1\text{mm} < \phi \leq 0.25\text{mm}$	3	
		$\phi > 0.25\text{mm}$	0	

### 3.1.3FPC

NO	Defect item	Criteria		Remark
1	Copper screen peel (minor defect)	Copper screen peel 【Reject】		
2	No release tape or peel	No release tape or peel 【Reject】		
3	Dirty dot and impurity of FPC for customer using side (minor defect)	Specification	Allowable	Note1: Cannot have stride ITO impurities
		$\phi \leq 0.25\text{mm}$	2	
		$\phi > 0.25$	0	

### 3.1.4Black tape & Mara tape

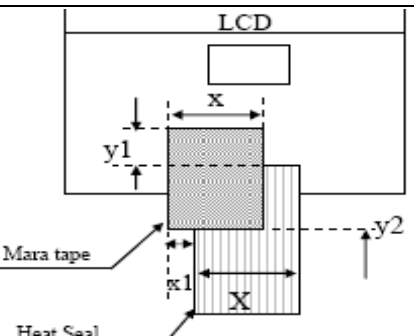
NO	Defect item	Criteria	Remark
1	FPC or H/S black tape (minor defect)	1. shift spec: 1) glue to the polarize 【Reject】 2) IC bare 【Reject】 2. left-and-right spec: 1) exceed of FPC edge or H-S edge 【Reject】 2) IC bare 【Reject】	

# 深圳市正晶浩电子有限公司

## SHENZHEN ZJH DISPLAYER TECHNOLOGYCO., LTD

服务热线: 133 9284 8764

2	No black tape (major defect)	No black tape 【Reject】	
3	Tape position mistake (minor defect)	Not by engineering drawing	
4	Mara tape defect (minor defect)	Peel before pulling the protecting film 【Reject】	

### 3.1.5 Silicon and Taffy glue

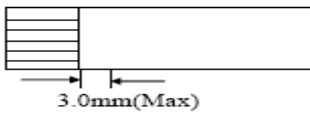
NO	Defect item	Criteria	Remark
1	Quantity of silicon (major defect)	Uncover the ITO and circuit area 【Reject】	note: compared by engineering
2	Taffy glue (major defect)	1.Uncover the reveal copper area【Reject】 2.Cover layer 0.3mm(Min)~3.0mm(Max) 【Reject】	note: if customer has special requirement, refer to the technical document 
3	Depth of glue covering (major defect)	Depth of glue covering overtop front Polarizer 【Reject】	Except of the special requirement

### 3.2Electrical criteria

NO	Defect item	Criteria	Remark
1	No display (major defect)	No display 【Reject】	
2	Missing line (major defect)	Missing line 【Reject】	
3	Seg-com light and dark (major defect)	Seg-com light and dark 【Reject】	ND filter 2% test
4	No display in immobility (major defect)	No display in immobility 【Reject】	
5	Flicker of Pattern (major defect)	Flicker of Pattern 【Reject】	
6	Mura (major defect)	ND filter 2% test	
7	Over current	Over current	

# 深圳市正晶浩电子有限公司

## SHENZHEN ZJH DISPLAYER TECHNOLOGYCO., LTD

服务热线：133 9284 8764

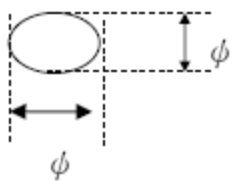
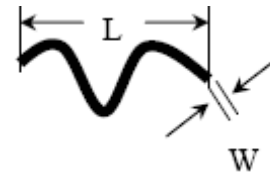
	(major defect)	【Reject】		
8	Voltage out of specification (major defect)	Voltage out of specification 【Reject】		
9	Pattern blur, error code (major defect)	Pattern blur, error code 【Reject】		
10	Dark light, Flicker (major defect)	Dark light, Flicker 【Reject】		
11	Black/white dots、Dirty dots、eye winker (major defect)	Specification	Allowable	Note1:disregard if out of AA 
		$\phi \leq 0.15\text{mm}$	disregard	
		$0.15\text{mm} < \phi \leq 0.25\text{mm}$	2	
		$0.25\text{mm} < \phi \leq 0.3\text{mm}$	1	
		$0.3\text{mm} < \phi$	0	
12	Fiber、glass crutch、Polarizer scratch/folded (major defect)	$W \leq 0.03\text{mm}$	disregard	Note1:L: Length, W: Width Note2: disregard if out of AA 
		$0.03\text{mm} < W \leq 0.05\text{mm}$ $L \leq 3.0\text{mm}$	2	
		$0.05\text{mm} < W \leq 0.1\text{mm}$ $L \leq 3.0\text{mm}$	1	
		$W > 0.1\text{mm}; L > 3.0\text{mm}$	0	

## 12.Precautions for using LCD modules.

### 12.1 Safety

- (1)Do not swallow any liquid crystal ,even if there is no proof that liquid crystal is poisonous.
- (2)If the LCD panel breaks, be careful not to get liquid crystal to touch your skin.
- (3)If skin is exposed to liquid crystal, wash the area thoroughly with alcohol or soap.

### 12.2Storage Conditions

- (4)Store the panel or module in a dark place where the temperature is  $23 \pm 5^{\circ}\text{C}$  and the humidity is below  $45 \pm 20\% \text{RH}$ .
- (5)Store in anti-static electricity container.
- (6)Store in clean environment, free from dust, active gas, and solvent.

# 深圳市正晶浩电子有限公司

## SHENZHEN ZJH DISPLAYER TECHNOLOGYCO., LTD

服务热线: 133 9284 8764

---

(7) Do not place the module near organics solvents or corrosive gases.

(8) Do not crush, shake, or jolt the module.

### 12.3 Handling Precautions

(9) Avoid static electricity, which can damage the CMOS LSI.

(10) The polarizing plate of the display is very fragile, please handle it very carefully.

(11) Do not give external shock.

(12) Do not apply excessive force on the surface.

(13) Do not wipe the polarizing plate with a dry cloth, as it may easily scratch the surface of plate.

(14) Do not use ketonic solvent & Aromatic solvent, use with a soft cloth soaked with a cleaning naphtha solvent.

(15) Do not operate it above the absolute maximum rating.

(16) Do not remove the panel or frame from the module.

### 12.4 Warranty

The period is within twelve months since the date of shipping out under normal using and storage conditions.

### 13. Revision history

Version	Revise record	Date
v0.0	Original version	2015-04-25

业务联系电话：

0755-29355801

133 9284 8764

QQ: 1553309801

交流QQ群：

370289556